

GlobalSat LW-360HR

User Manual



Version: 1.0

GlobalSat WorldCom Corporation

16F., No. 186, Jian 1st Rd, Zhonghe Dist.,

New Taipei City 23553, Taiwan

Tel: 886.2.8226.3799/ Fax: 886.2.8226.3899

lora@globalsat.com.tw

www.globalsat.com.tw

USGlobalSat Incorporated

14740 Yorba Court Chino, CA 91710

Tel: 888.323.8720 / Fax: 909.597.8532

sales@usglobalsat.com

TABLE OF CONTENTS

1. Warning	3
2. Welcome.....	4
3. Introduction and Features	5
4. Device Operation	6
4.1 Device charging.....	6
4.2 First Time Use	7
4.3 How to Wear Device for Heart Rate Detect.....	7
4.4 Change Watch Band	8
5. General Settings	9
5.1 Time mode	9
5.2 Menu setting.....	9
5.3 Health page setting	10
5.4 Activity page setting.....	10
5.5 Alarm setting page.....	11
5.6 Setting page- System	12
5.6 Setting page- Profile.....	15
5.7 Setting page- Factory reset.....	16
5.8 Setting page- System upgrade.....	16
5.9 Setting page- About	17
6. Alert Trigger	18
6.1 Help Alert.....	18
6.2 Static Alert	19
6.3 Fall-down Advisory Alert	20
6.4 Low Heart Rate Alert.....	21
5. Safety Information	22
6. Limited Warranty.....	22
7. FCC Warning.....	26

1. Warning



USE RESPONSIBLY. READ ALL INSTRUCTIONS AND SAFETY INFORMATION BEFORE USE.

GlobalSat WorldCom Corporation / USGlobalSat, Inc., will not accept any responsibility whatsoever for accidents or violations of local Laws resulting from failure to observe common sense precautions and local laws. Your personal judgment, traffic regulations, and common sense must always take precedence over any directions produced by GPS receiver or the mapping software.

Indemnification:

User agrees to defend, indemnify and hold harmless GlobalSat WorldCom Corp. and USGlobalSat, Inc., its officers, directors, employees and agents against and from any third party claims, actions, damages or demands, including but not limited to, reasonable legal and accounting fees, resulting from user's use or misuse of this product, violation of these Terms, or any activities related to this product, or from user's violations of the rights of any other user of this product. Use of this Product is at user's own risk.

2. Welcome

Thank you for purchasing the GlobalSat LW-360HR. The LW-360HR is a sleek, compact and feature rich personal tracking device. The LW-360HR unit incorporates a wide array of custom feature, functions and configurations for unique client requirements. We appreciate your purchase of a GlobalSat WorldCom Product!



3. Introduction and Features





To power on/off by holding POWER button 2 seconds
 To Trigger help alert by holding ENTER button 3 seconds

Icon definition



LoRa

	Wait to transmit LoRa signal
 Flashing	Transmitting LoRa signal



BLE

	Wait to scan beacon signal
 Flashing	Scanning beacon signal

GPS

	Wait to scan GPS signal
 Flashing	Scanning GPS signal
	3D Fix

Other

	Battery capacity
	Alarm clock is set

4. Device Operation

4.1 Device charging

1. Plug USB cable into the back of device. Note that arrows in USB cable and back cover of device have to be in the same side as below picture. (Do not plug in inverse direction.)

Caution: Product will be damaged if cable is not plugged in correct direction.

2. Before charging, make sure the connecting parts of both device and USB cable are dry and clean.
3. Make sure charging icon appears when charging.

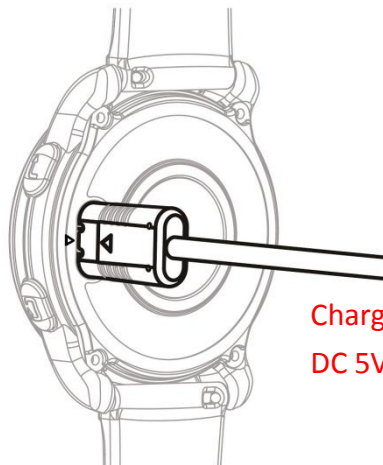
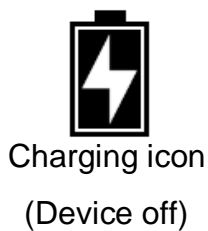

Charging Input Voltage and Current:
DC 5V /1A

Caution:

Warranty will be invalid for any damage caused by incorrect use of USB cable.

4.2 First Time Use

Please fully charge your device before first time use. Then, press and hold [Power] button for 2 seconds to turn on device.



4.3 How to Wear Device for Heart Rate Detect

Please wear device in below recommended part of your wrist (back of wrist bone) for good heart rate detect. Device should be tied enough without slipping back and forth on your wrist.

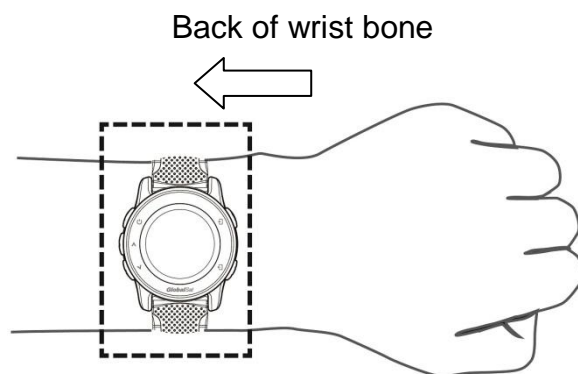

4.4 Change Watch Band

You can easily change watch band by the design of quick change band. Just slide the latch in the direction as below picture and you can take the band apart from the watch main unit.

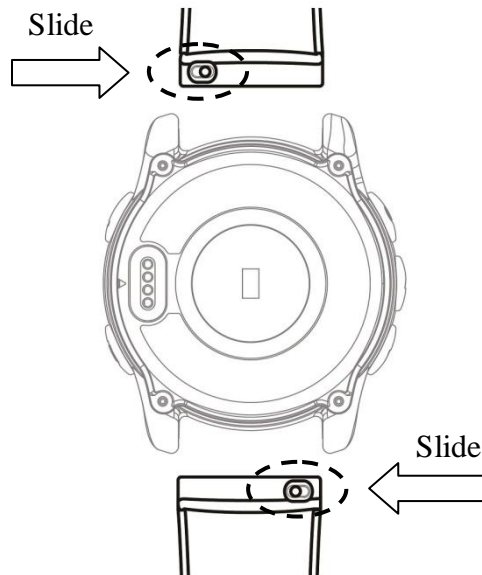

5. General Settings

5.1 Time mode

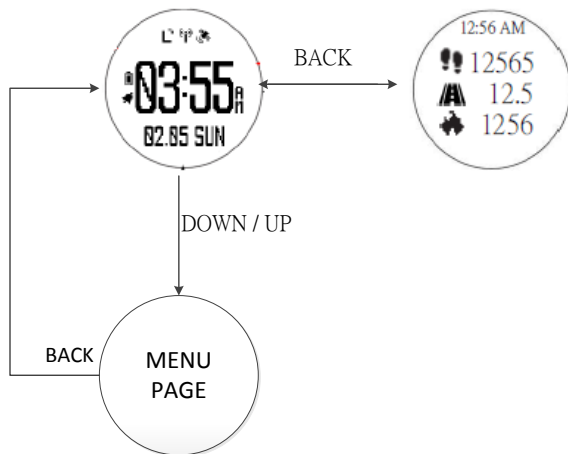

5.2 Menu setting

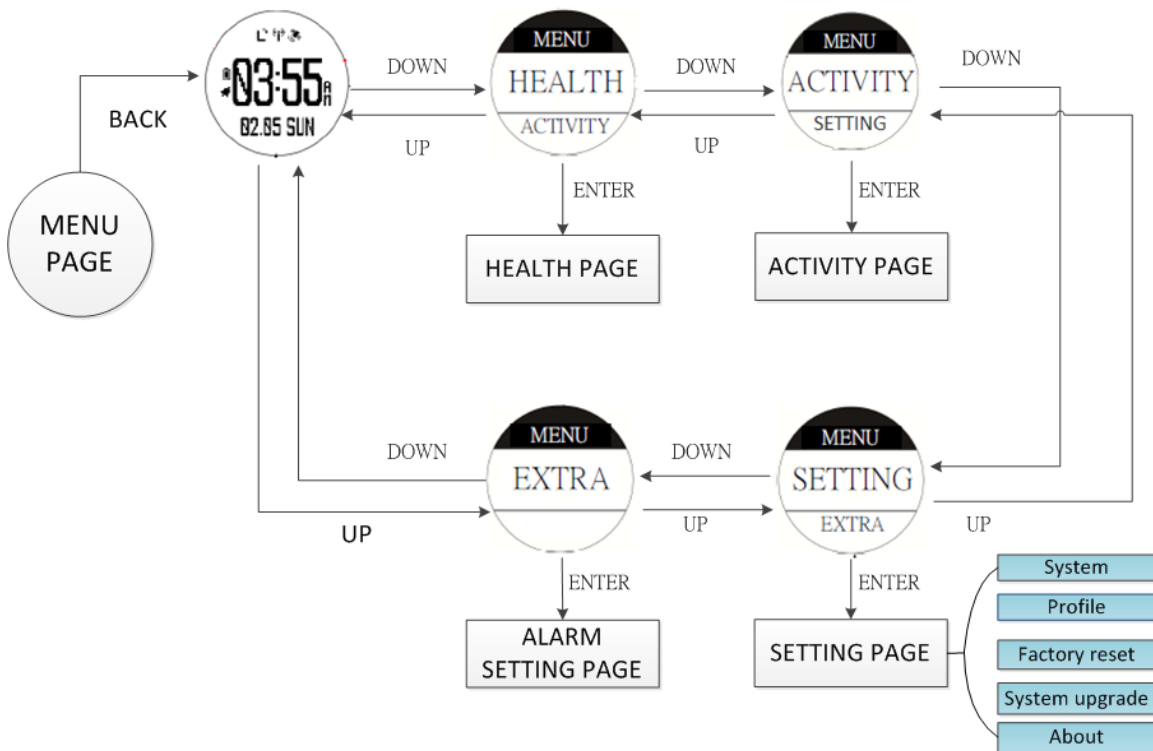

5.3 Health page setting

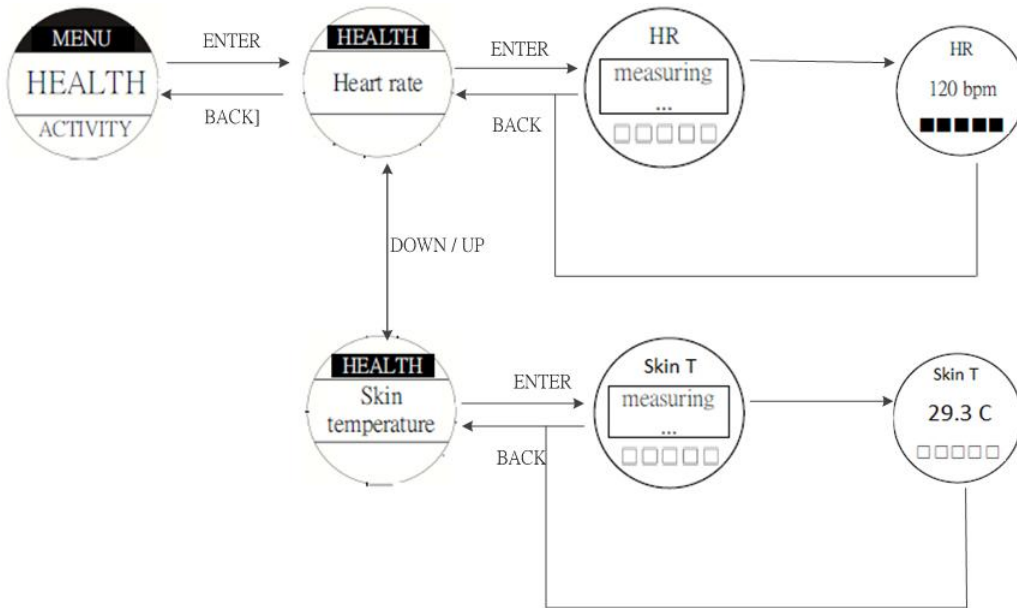

5.4 Activity page setting

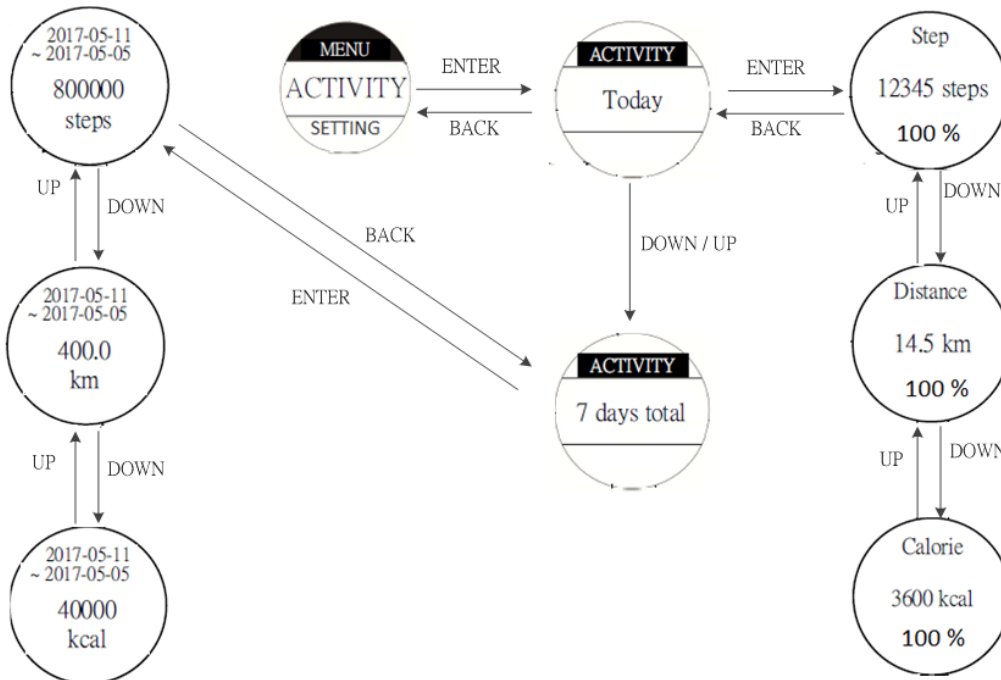

5.5 Alarm setting page

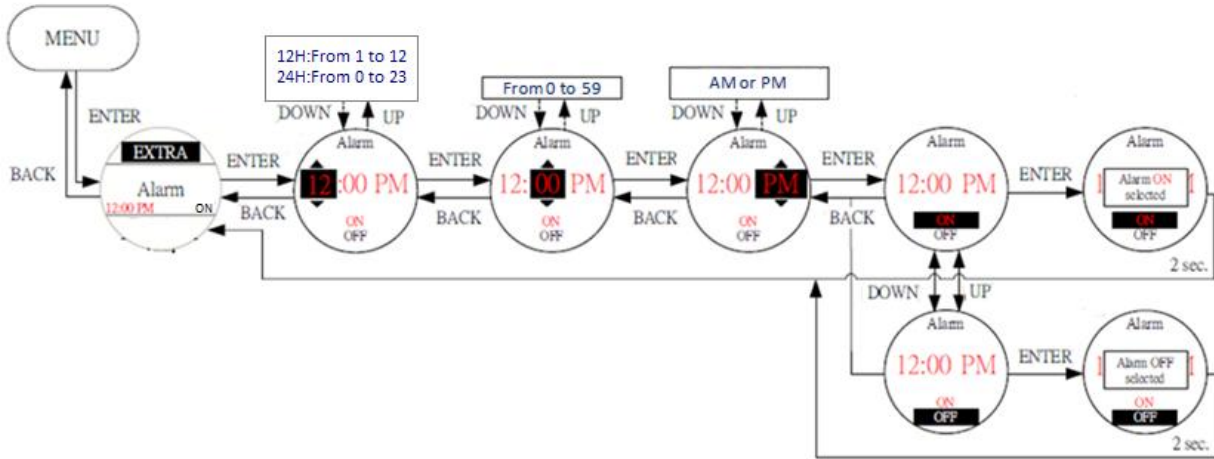

In 'SETTING' -> 'System' -> 'Time format', you could select to use time format to be 12H or 24H.

5.6 Setting page- System

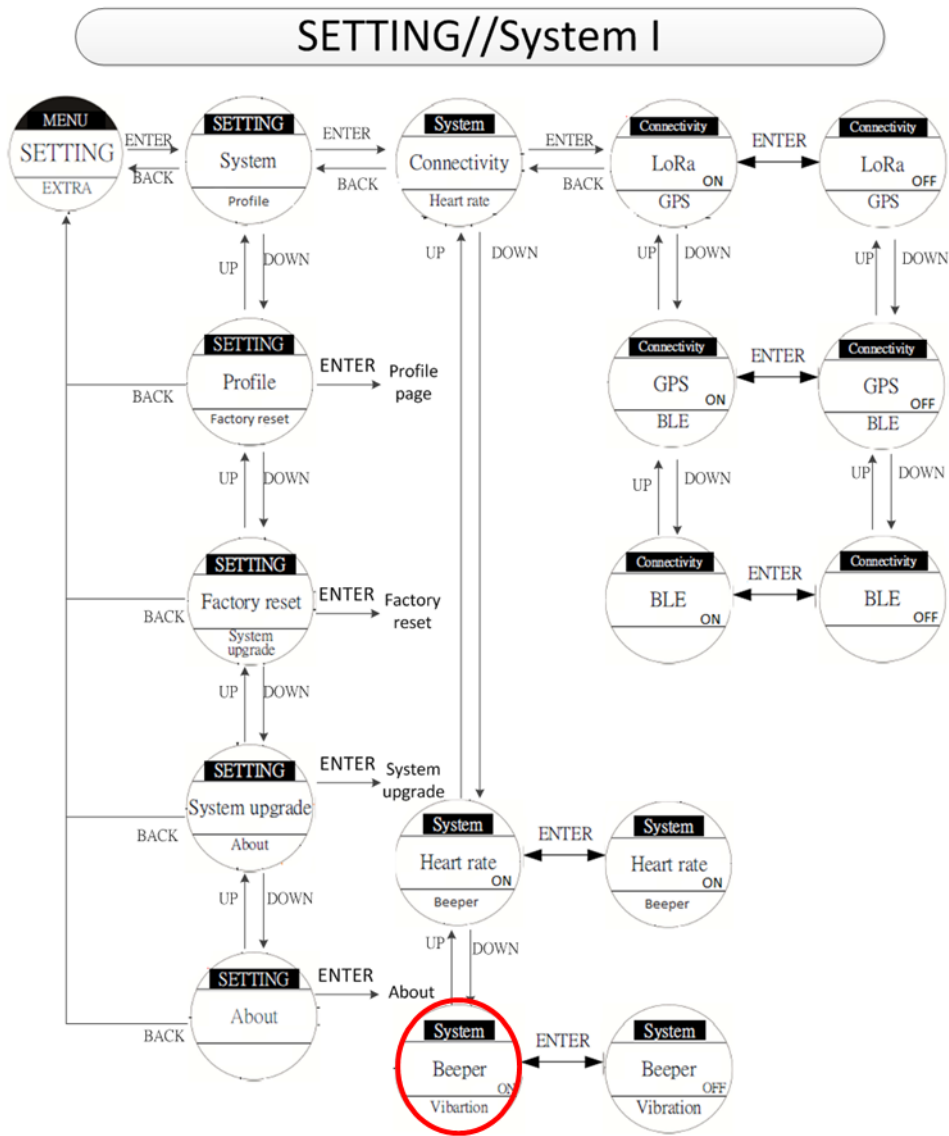

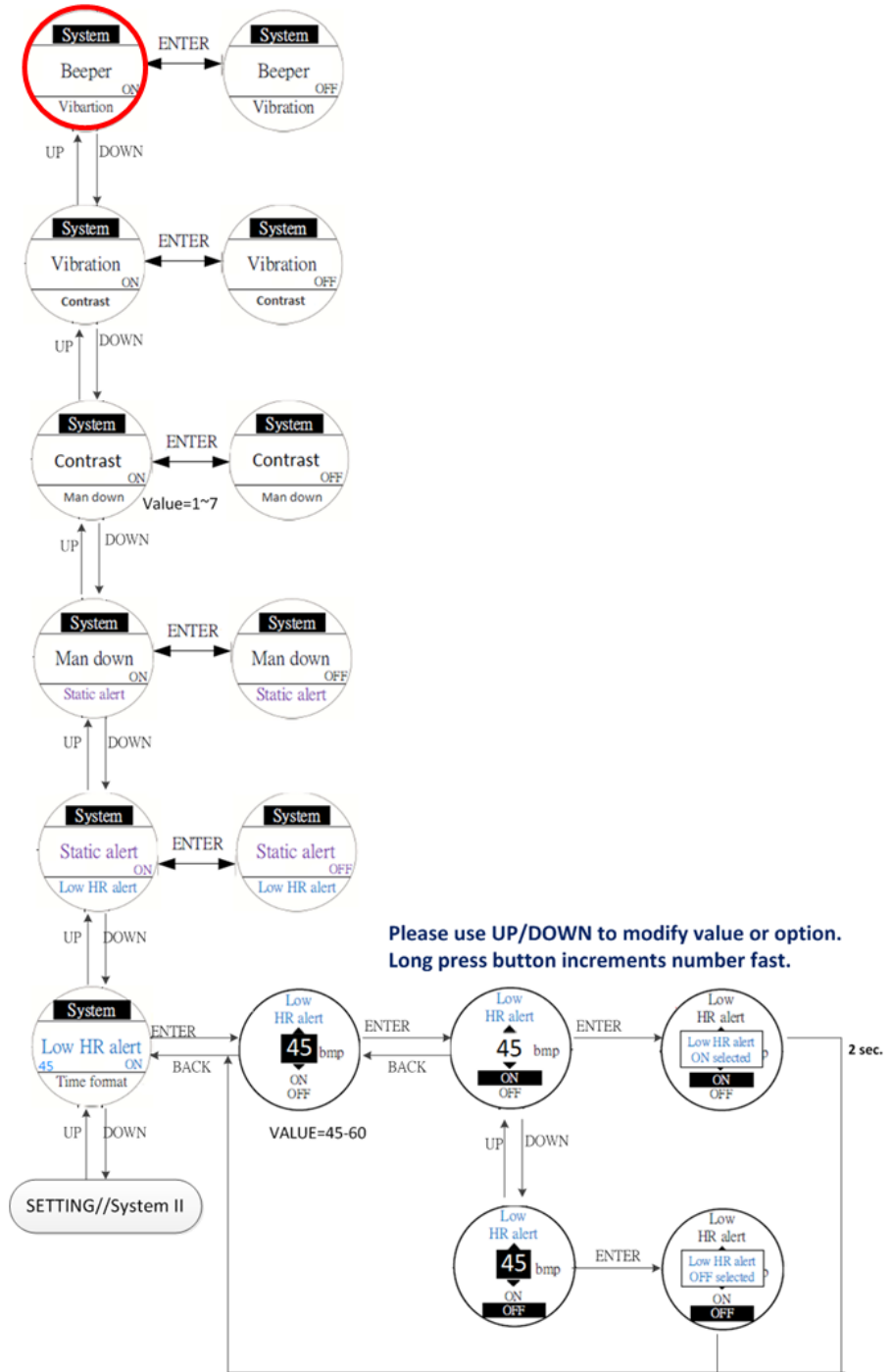

SETTING//System II

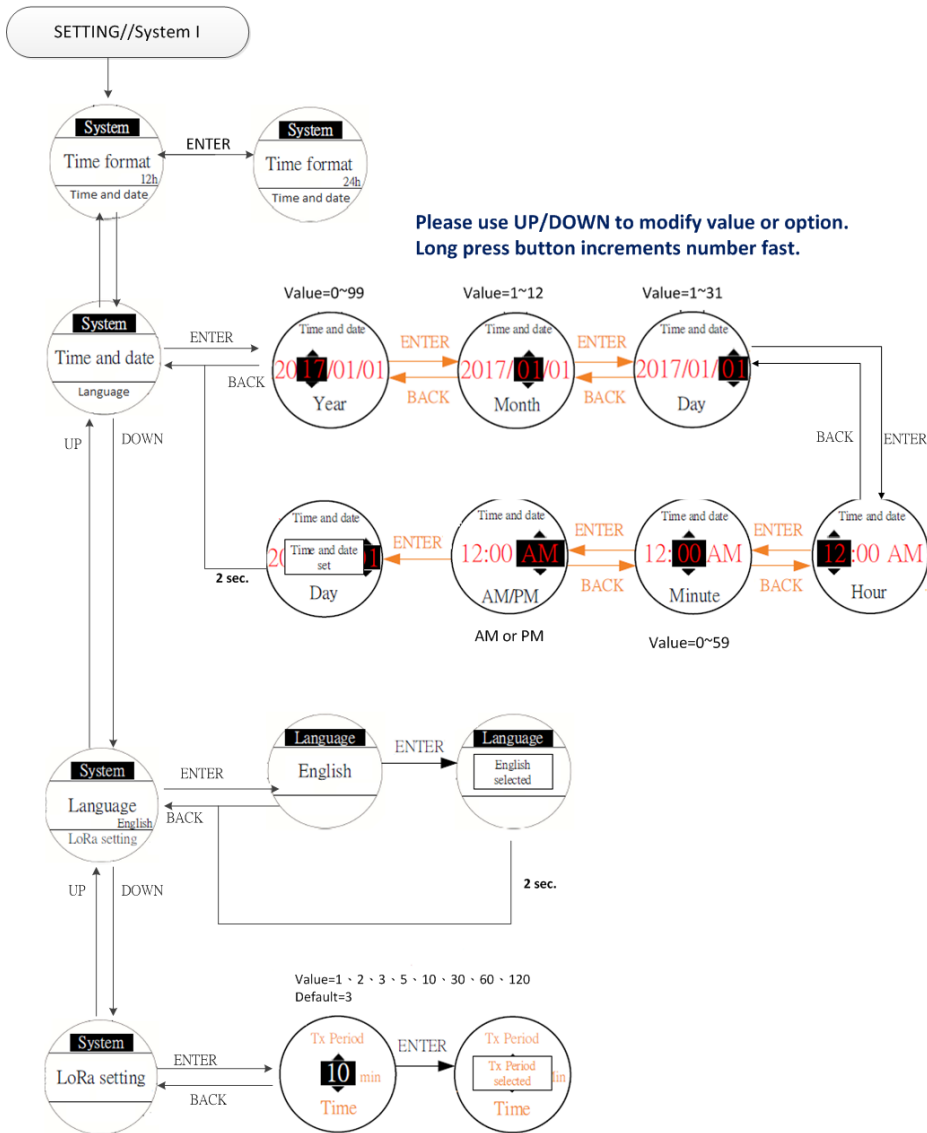

5.6 Setting page- Profile

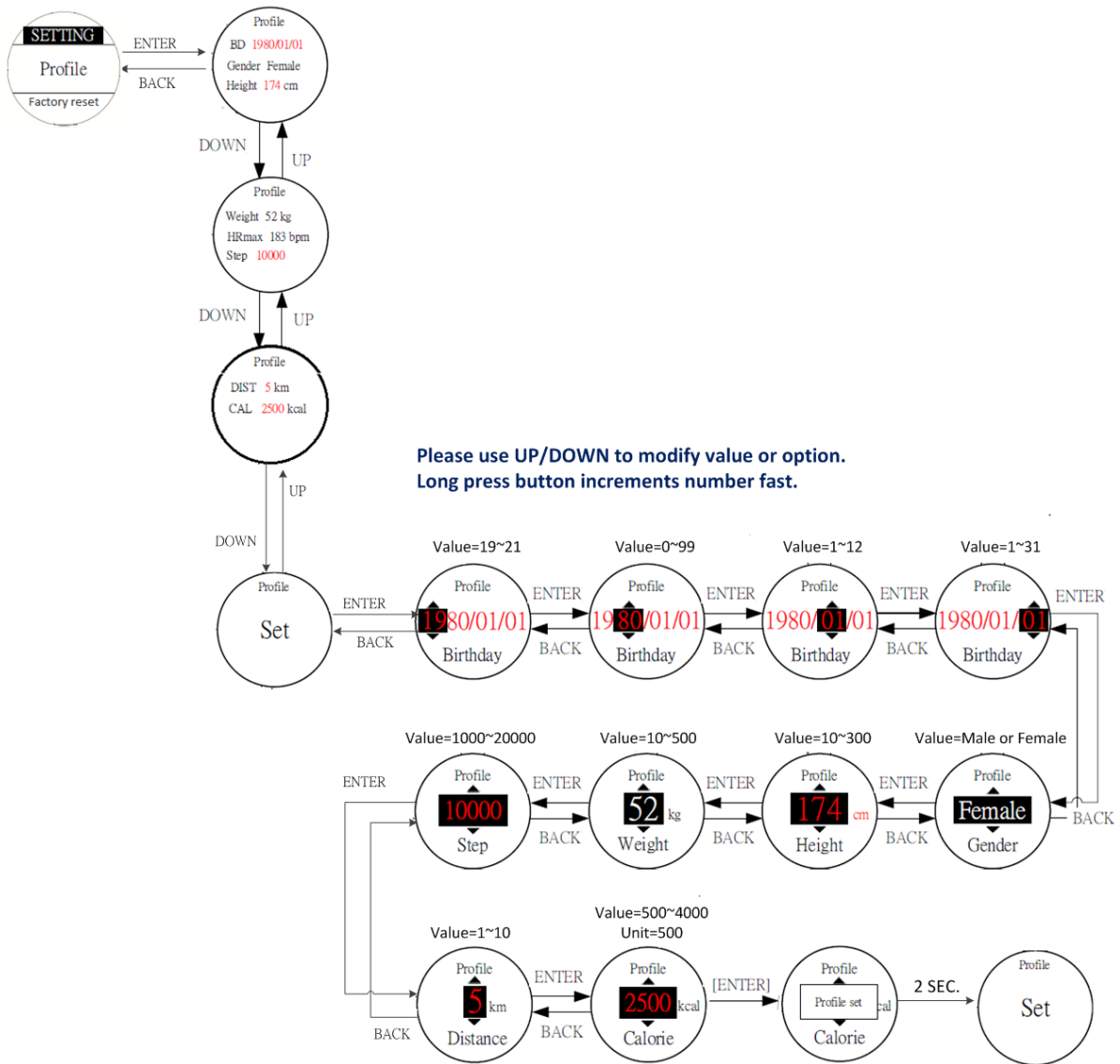

5.7 Setting page- Factory reset

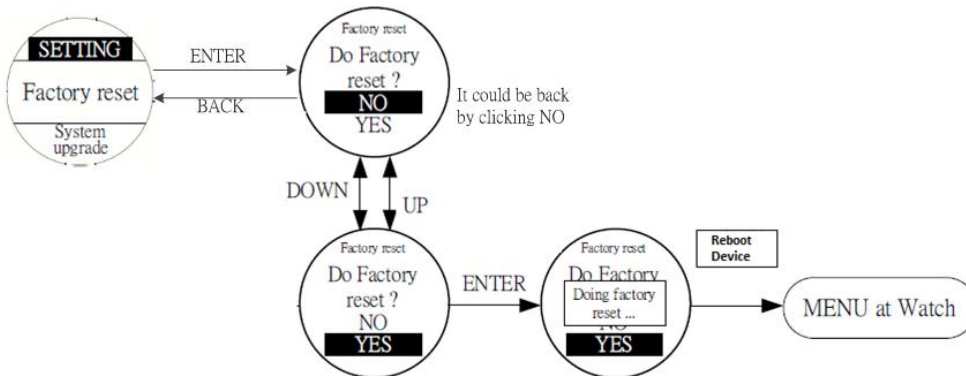

5.8 Setting page- System upgrade



Note: It requires to contact our sales for new firmware if necessary.

5.9 Setting page- About

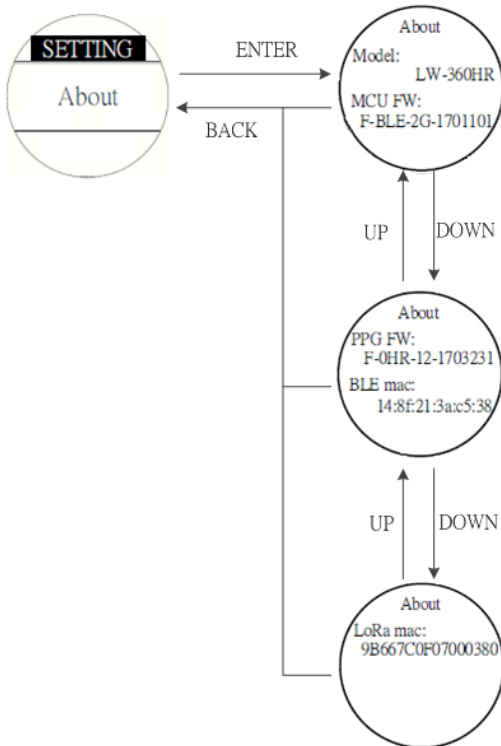

6. Alert Trigger

6.1 Help Alert

It will trigger help alert with vibration 1 second by hold [Enter] 3 seconds. Then it would send help report every 30 seconds. It could be dismissed by clicking Stop.

Note: When help alert is triggered, LoRa/BLE/GPS are forced to be enable no matter which original settings are set.

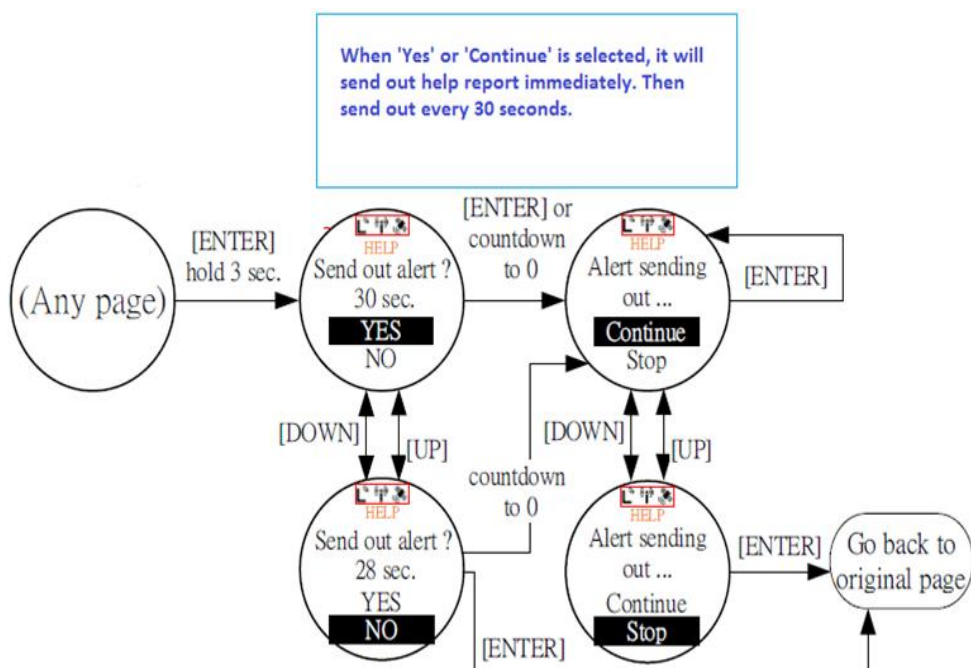

6.2 Static Alert

This feature could be enabled in menu 'SETTING' -> 'System' -> 'Static alert'.

When device doesn't move over 30 seconds by G-sensor detection, it will trigger static alert with vibration 1 second. It could be dismissed by clicking Stop.

Note: When static alert is triggered, LoRa/BLE/GPS are forced to be enable no matter which original settings are set.

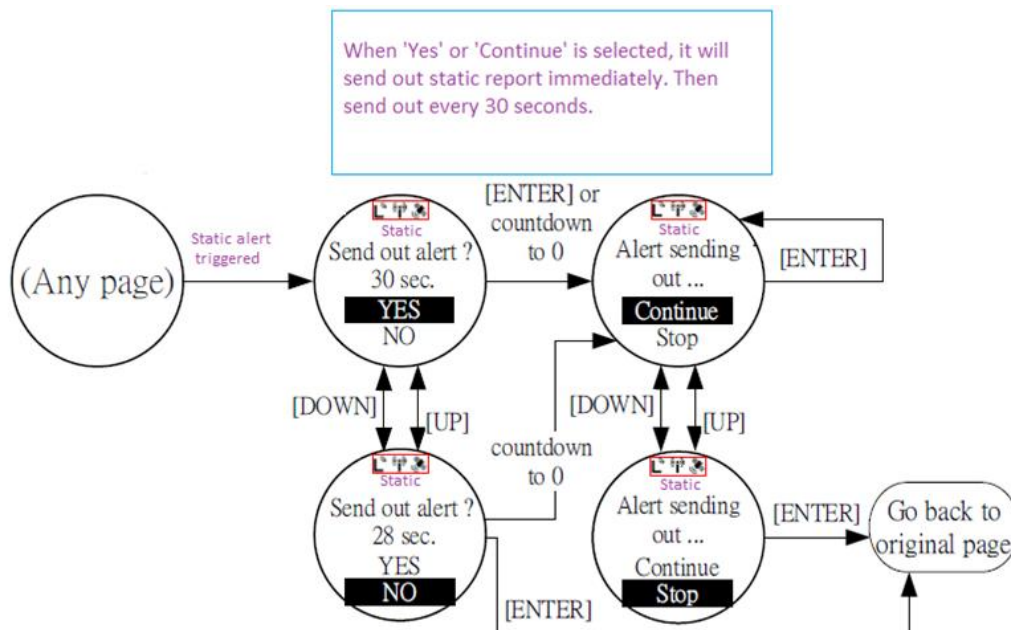

6.3 Fall-down Advisory Alert

This feature could be enabled in menu 'SETTING' -> 'System' -> 'Man down'.

When wearer falls down by G-sensor detection, it will trigger fall-down advisory alert with vibration 1 second. It could be dismissed by clicking Stop.

Note: When fall-down advisory alert is triggered, LoRa/BLE/GPS are forced to be enable no matter which original settings are set.

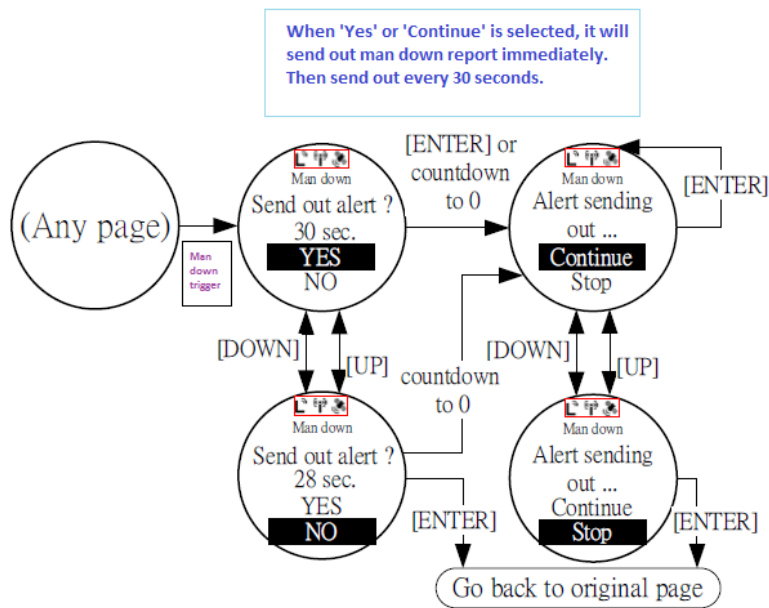

6.4 Low Heart Rate Alert

This feature could be enabled and the range of low heart rate can be set in menu 'SETTING' -> 'System' -> 'Low HR alert'. The range of low heart rate is from 45~60. When wearer's heart rate is lower than 45 bpm according to default setting, it will trigger low heart rate alert with vibration 1 second. It could be dismissed by clicking Stop.

Note: When low heart rate alert is triggered, LoRa/BLE/GPS are forced to be enable no matter which original settings are set.

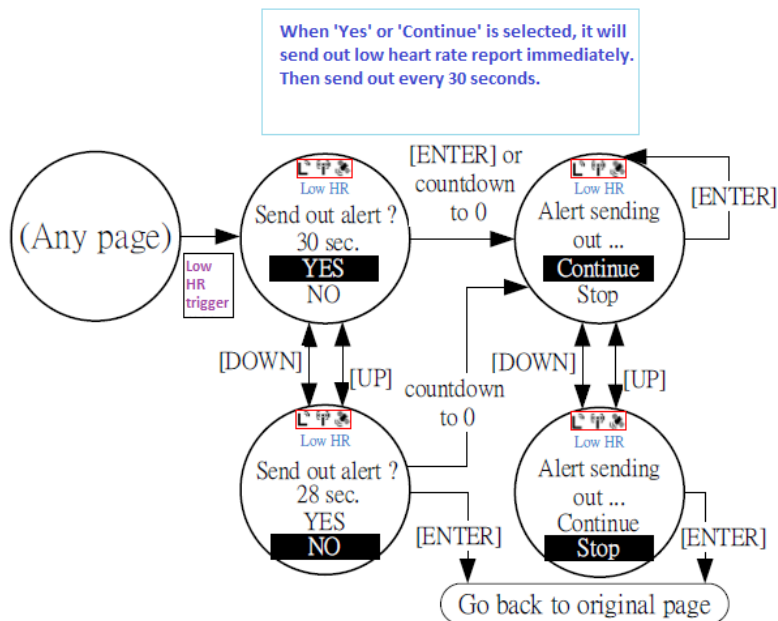

5. Safety Information

- Avoid use in humid or rainy environment. Water ingress can disable or destroy this product beyond repair.
- Avoid using this product in a dusty environment. Dust ingress can compromise the products ability to function.
- Avoid situations that include Over-voltage, over charging, power cable damage may cause overheating or potential fire disaster.
- Never use any chemical or detergent to clean the Device to prevent erosion of the surface or paintwork.
- In order to eliminate the risk of electric shock, make certain the charging cable is completely inserted / seated, do not touch the power cable plug / connectors with wet or damp hands.
- Do not charge the Device in any extreme cold or hot temperatures, which may cause damage to the device.
- Keep out of the reach of children during charging.
- Avoid direct prolonged exposure to sunlight and high temperatures to avoid the potential over-heating of the battery of this product, which may cause damage.
- Please do not attempt to repair this device yourself, contact GlobalSat or USGlobalSat for Technical Support.
- Keep all the wires tidy in order to prevent damage or tangling.

6. Limited Warranty

GlobalSat/ USGlobalSat (1) Year Limited Warranty

FOR CONSUMERS, WHO ARE COVERED BY CONSUMER PROTECTION LAWS OR REGULATIONS IN THEIR COUNTRY OF PURCHASE OR, IF DIFFERENT, IN THEIR COUNTRY OF RESIDENCE, THE BENEFITS CONFERRED BY THIS WARRANTY ARE IN ADDITION TO ALL RIGHTS AND REMEDIES CONVEYED BY SUCH CONSUMER PROTECTION LAWS AND REGULATIONS. THIS WARRANTY DOES NOT EXCLUDE, LIMIT OR SUSPEND ANY RIGHTS OF CONSUMERS ARISING OUT OF NONCONFORMITY WITH A SALES CONTRACT. SOME COUNTRIES, STATES AND PROVINCES DO NOT ALLOW THE EXCLUSION OR LIMITATION OF INCIDENTAL OR CONSEQUENTIAL DAMAGES OR ALLOW LIMITATIONS ON HOW LONG AN IMPLIED WARRANTY OR CONDITION MAY LAST, SO THE LIMITATIONS OR EXCLUSIONS DESCRIBED BELOW MAY NOT APPLY TO YOU. THIS WARRANTY GIVES YOU SPECIFIC LEGAL



RIGHTS, AND YOU MAY ALSO HAVE OTHER RIGHTS THAT VARY BY COUNTRY, STATE OR PROVIDENCE. THIS LIMITED WARRANTY IS GOVERNED BY AND CONSTRUED UNDER THE LAWS OF THE COUNTRY IN WHICH PRODUCT PURCHASE TOOK PLACE. GLOBALSAT/ USGLOBALSAT, THE WARRANTOR UNDER THIS LIMITED WARRANTY, IS IDENTIFIED AT THE END OF THIS DOCUMENT ACCORDING TO THE COUNTRY OR REGION IN WHICH THE PRODUCT PURCHASE TOOK PLACE.

GlobalSat/ USGlobalSat's warranty obligations for this hardware product are limited to the terms set forth below:

GlobalSat/ USGlobalSat, as defined below, warrants this hardware product against defects in materials product hardware against manufacturing defects in materials and workmanship under normal use for a period of ONE (1) year from the date of retail purchase by the original end-user purchaser and purchased from a recognized "authorized dealer" ("Warranty Period"). Products purchased from any unauthorized source, such as unauthorized e-Bay resellers, will not qualify for free warranty service/support and may require the end-user to pre-pay fees associated with, but not limited to the support, repair, replacement and shipping of the product to and from the service center. If a hardware defect arises and a valid claim is received by GlobalSat/ USGlobalSat within the Warranty Period, at its option and to the extent permitted by law, GlobalSat/ USGlobalSat will either (1) repair the product at no charge, using new parts or parts equivalent to new in performance and reliability, (2) exchange the product with a product that is new or equivalent to new in performance and reliability and is at least functionally equivalent to the original product or, (3) refund the purchase price of the product. GlobalSat/ USGlobalSat may request that you replace defective parts with new or refurbished user-installable parts that GlobalSat/ USGlobalSat provides in fulfillment of its warranty obligation. A replacement product or part, including a user-installable part that has been installed in accordance with instructions provided by GlobalSat/ USGlobalSat, assumes the remaining warranty of the original product or ninety (90) days from the date of replacement or repair, whichever provides longer coverage for you. When a product or part is exchanged, any replacement item becomes your property and the replaced items become GlobalSat/ USGlobalSat's property. Parts provide by GlobalSat/ USGlobalSat in fulfillment of its warranty obligation must be used in products for which warranty service is claimed. When a refund is given, the product for which the refund is provided must be returned to GlobalSat/ USGlobalSat and becomes GlobalSat/ USGlobalSat's property.

If a defect arises and a valid claim is received by GlobalSat/ USGlobalSat after the first one hundred and eighty (180) days of Warranty period, a shipping and handling charge may apply to any repair or exchange of the product undertaken by GlobalSat/ USGlobalSat.

EXCLUSIONS AND LIMITATIONS

This Limited Warranty applies only to the hardware product manufactured by or for GlobalSat that can be identified by the "GlobalSat" trademark, trade name, or logo annexed to it. The Limited Warranty does not apply to any non-GlobalSat hardware product or any software, even if packaged or sold with



the GlobalSat hardware.

Manufacturers, suppliers, or publishers, other than GlobalSat/ USGlobalSat, may provide their own warranties to the end user purchaser, but GlobalSat/ USGlobalSat, in so far as permitted by law, provides their products “as-is”. Software distributed by GlobalSat/ USGlobalSat with or without the GlobalSat brand name (including, but not limited to system software) is not covered under this Limited Warranty. Refer to the licensing agreement accompanying the software for details of your rights with respect to its use. GlobalSat/ USGlobalSat does not warrant that the operation of the product will be uninterrupted or error-free. GlobalSat/

USGlobalSat is not responsible for damage arising from failure to follow instructions relating to the product’s use.

This warranty does not apply: (a) to consumable parts, such as batteries, unless damage has occurred due to a defect in materials and workmanship; (b) to cosmetic damage, including but not limited to scratches, dents, and broken plastic on ports; (c) to damage caused by use accident, abuse, misuse, flood, fire, earthquake or other external causes; (e) to damage caused by operating the product outside the permitted or intended uses described by GlobalSat/ USGlobalSat; (f) to damage caused by service (including upgrades and expansions) performed by anyone who is not a representative of GlobalSat/ USGlobalSat or an GlobalSat/ USGlobalSat authorized service provider; (g) to a product or part that has been modified to alter functionality or capability without the written permission of GlobalSat/ USGlobalSat; or (h) if any GlobalSat/ USGlobalSat serial number has been removed or defaced.

IMPORTANT: Do not open the hardware product. Opening the hardware product may cause damage that is not covered by this warranty. Only GlobalSat/ USGlobalSat or an authorized service provider should perform service on this hardware product.

TO THE EXTENT PERMITTED BY LAW, THIS WARRANTY AND THE REMEDIES SET FORTH ABOVE ARE EXCLUSIVE AND IN LIEU OF ALL OTHER WARRANTIES, REMEDIES AND CONDITIONS, WHETHER ORAL OR WRITTEN, STATUTORY, EXPRESS OR IMPLIED. AS PERMITTED BY APPLICABLE LAW, GLOBALSAT/ USGLOBALSAT SPECIFICALLY DISCLAIMS ANY AND ALL STATUTORY OR IMPLIED WARRANTIES, INCLUDING, WITHOUT LIMITATION, WARRANTIES OF MERCHANTABILITY AND FITNESS FOR A PARTICULAR PURPOSE AND WARRANTIES AGAINST HIDDEN OR LATENT DEFECTS. IF GLOBALSAT/ USGLOBALSAT CANNOT LAWFULLY DISCLAIM STATUTORY OR IMPLIED WARRANTIES THEN TO THE EXTENT PERMITTED BY LAW, ALL SUCH WARRANTIES SHALL BE LIMITED IN DURATION OF THE EXPRESS WARRANTY AND TO THE REPAIR OR REPLACEMENT SERVICE AS DETERMINED BY GLOBALSAT/ USGLOBALSAT IN ITS SOLE DISCRETION.



No GlobalSat/ USGlobalSat reseller, agent, or employee is authorized to make any modifications, extension, or addition to this warranty. If any term is held to be illegal or unenforceable, the legality or enforceability of the remaining terms shall not be affected or impaired.

EXCEPT AS PROVIDED IN THIS WARRANTY AND TO THE MAXIMUM EXTENT PERMITTED BY LAW, GLOBALSAT/ USGLOBALSAT IS NOT RESPONSIBLE FOR DIRECT, SPECIAL, INCIDENTAL OR CONSEQUENTIAL DAMAGES RESULTING FROM ANY BREACH OF WARRANTY OR CONDITION, OR UNDER ANY OTHER LEGAL THEORY, INCLUDING BUT NOT LIMITED TO LOSS OF USE; LOSS OF REVENUE; LOSS OF ACTUAL OR ANTICIPATED PROFITS (INCLUDING LOSS OF PROFITS ON CONTRACTS); LOSS OF THE USE OF MONEY; LOSS OF ANTICIPATED SAVINGS; LOSS OF BUSINESS; LOSS OF OPPORTUNITY; LOSS OF GOODWILL; LOSS OF REPUTATION; LOSS OF; DAMAGE TO OR CORRUPTION OF DATA; OR ANY INDIRECT OR CONSEQUENTIAL LOSS OR DAMAGE HOWSOEVER CAUSED INCLUDING THE REPLACEMENT OF EQUIPMENT AND PROPERTY, ANY COSTS OF RECOVERING, PROGRAMMING OR REPRODUCING ANY PROGRAM OR DATA STORED IN OR USED WITH THE GLOBALSAT/ USGLOBALSAT PRODUCT AND ANY FAILURE TO MAINTAIN THE CONFIDENTIALITY OF DATA STORED ON THE PRODUCT. THE FOREGOING LIMITATION SHALL NOT APPLY TO DEATH OR PERSONAL INJURY CLAIMS, OR ANY STATUTORY LIABILITY FOR INTENTIONAL AND GROSS NEGLIGENT ACTS AND/OR OMISSIONS. GLOBALSAT/ USGLOBALSAT DISCLAIMS ANY REPRESENTATION THAT IT WILL BE ABLE TO REPAIR ANY PRODUCT UNDER THIS WARRANTY OR MAKE A PRODUCT EXCHANGE WITHOUT RISK TO OR LOSS OF PROGRAMS OR DATA.

OBTAINING WARRANTY SERVICE

Please access and review the online help resources referred to in the documentation accompanying this hardware product before seeking warranty service. If the product is still not functioning properly after making use of these resources, access the online website www.usglobalsat.com for instructions on how to obtain warranty service. You must follow GlobalSat/ USGlobalSat warranty processes. GlobalSat/ USGlobalSat may provide warranty service (i) by sending the unit to GlobalSat/ USGlobalSat location, where service is performed at the location, or (ii) by sending the unit to an authorized GlobalSat/ USGlobalSat supplier (iii) by sending you new or refurbished customer-installable replacement product or parts to enable you to service or exchange your own product ("RMA service"). Upon receipt of the replacement product or part, the original product or part becomes the property of GlobalSat/ USGlobalSat and you agree to follow instructions, including, if requires, arranging the return of the product or part to GlobalSat/ USGlobalSat in a timely manner. When providing RMA service requiring the return of the original product or part, GlobalSat/ USGlobalSat may require credit card authorization as security for the retail price of the replacement product or part and applicable shipping costs. If you follow the instructions, GlobalSat/ USGlobalSat will cancel the



credit card authorization, so you will not be charged for the product or part and shipping costs. If you fail to return the replace product or part as instructed, GlobalSat/ USGlobalSat will charge the credit card for the authorized amount. Service options, parts availability and response times may vary according to the country in which

service is requested. Service options are subject to change at any time. You may be responsible for shipping and handling charges if product cannot be serviced in the country in which service is requested. If you seek service in a country that is not the country of purchase, you will comply with applicable export laws and regulations and be responsible for all custom duties, V.A.T. and other associated taxes and charges. For international service, GlobalSat/ USGlobalSat may repair or exchange defective products and parts with comparable products and parts that comply with local standards. In accordance with applicable law, GlobalSat/ USGlobalSat may require that you furnish proof of purchase details and/ or comply with the registration requirements before receiving warranty service.

Please refer to the accompanying documentation for more details on this and other matters obtaining warranty service.

GlobalSat/ USGlobalSat will maintain and use customer information in accordance with the GlobalSat/ USGlobalSat Privacy Policy.

If your product is capable of storing software programs, data and other information, you should make periodic backup copies of the information contained on the product's hard drive or other storage media to protect the contents and as a precaution against possible operational failures. Before you deliver your product for warranty service it is your responsibility to keep a separate backup copy of the contents, and disable any security passwords. IT IS POSSIBLE THAT THE CONTENTS OF YOUR HARD DRIVE WILL BE LOST OR REFORMATTED IN THE COURSE OF WARRANTY SERVICE, AND GLOBALSAT/ USGLOBALSAT AND ITS AGENTS ARE NOT RESPONSIBLE FOR ANY DAMAGE TO OR LOSS OF PROGRAMS, DATA OR OTHER INFORMATION CONTAINED ON THE MEDIA OR ANY PART OF THE PRODUCT SERVICED. Your product will be returned to you configured as originally purchased, subject to applicable updates. You will be responsible for reinstalling all other software programs, data and passwords. Recovery and reinstallation of service programs and user data are not covered under this Limited Warranty.

7. FCC Warning

Federal Communication Commission Interference Statement

This device complies with Part 15 of the FCC Rules. Operation is subject to the following two conditions: (1) This device may not cause harmful interference, and (2) this device must accept any interference received, including interference that may cause undesired



operation.

This equipment has been tested and found to comply with the limits for a Class B digital device, pursuant to Part 15 of the FCC Rules. These limits are designed to provide reasonable protection against harmful interference in a residential installation. This equipment generates, uses and can radiate radio frequency energy and, if not installed and used in accordance with the instructions, may cause harmful interference to radio communications. However, there is no guarantee that interference will not occur in a particular installation. If this equipment does cause harmful interference to radio or television reception, which can be determined by turning the equipment off and on, the user is encouraged to try to correct the interference by one of the following measures:

- Reorient or relocate the receiving antenna.
- Increase the separation between the equipment and receiver.
- Connect the equipment into an outlet on a circuit different from that to which the receiver is connected.
- Consult the dealer or an experienced radio/TV technician for help.

FCC Caution: Any changes or modifications not expressly approved by the party responsible for compliance could void the user's authority to operate this equipment.

This transmitter must not be co-located or operating in conjunction with any other antenna or transmitter.

Radiation Exposure Statement

The product comply with the FCC portable RF exposure limit set forth for an uncontrolled environment and are safe for intended operation as described in this manual. The further RF exposure reduction can be achieved if the product can be kept as far as possible from the user body or set the device to lower output power if such function is available